





ORGANIZE IT ALL®

PLEASE READ INSTRUCTIONS COMPLETELY BEFORE ASSEMBLY

For assistance or missing parts in the USA, please email **customerservice@kennedy-intl.com** or call **Monday thru Friday (732) 654-2770**
All international (outside USA) customers who have missing, defective or damaged parts must contact the retailer directly to make an exchange or return for refund. All other customer service product and/or questions may be directed to us (in English).

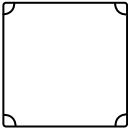
Style: NH-15901W-1

#	①	②
PARTS		
QTY	16	18

No Tool Required

A INSERT CONNECTOR INTO EACH CORNER

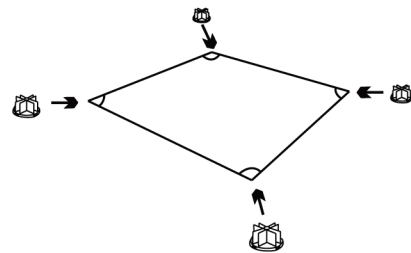

B ADD PP PANELS

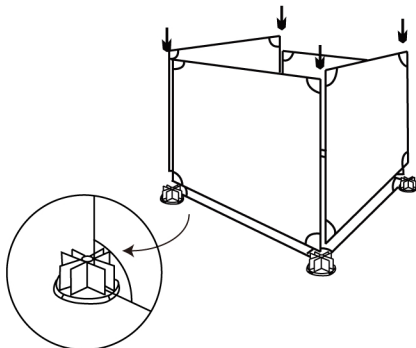

C MAKE SURE PLASTIC JOINTS ARE FULLY INSERTED

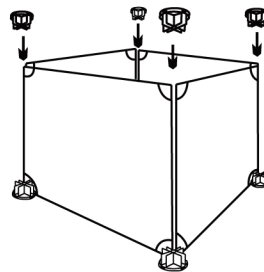

DESIGN YOUR OWN STACKING CUBE

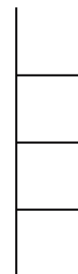
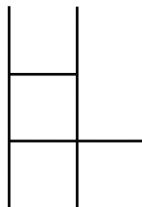
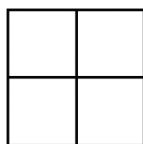

WARNING

Please Note the Following Guidelines to Ensure Long Term Usage

MAXIMUM WEIGHT CAPACITY (EACH SHELF): 10 LBS; TEMPERATURE TOLERANCES: 32°F - 122°F

PLEASE NOTE:

We will accept missing parts request with proof of purchase only, within 30 days of purchase.

All return merchandise must be returned directly to the store and not the manufacturer with the proof of purchase.