











ORGANIZE IT ALL.

PLEASE READ INSTRUCTIONS COMPLETELY BEFORE ASSEMBLY

For assistance or missing parts in the USA, please email customerservice@kennedy-intl.com or call **Monday thru Friday (732) 654-2770**
All international (outside USA) customers who have missing, defective or damaged parts must contact the retailer directly to make an exchange or return for refund. All other customer service product and/or questions may be directed to us (in English).

Style: 23543

#	A	B	C	D	E	F	G	H	I
PARTS									
QTY	2	3	12	1	4	8	4	4	1

Weight Capacity per layer: 11LBS/ 5 KGS

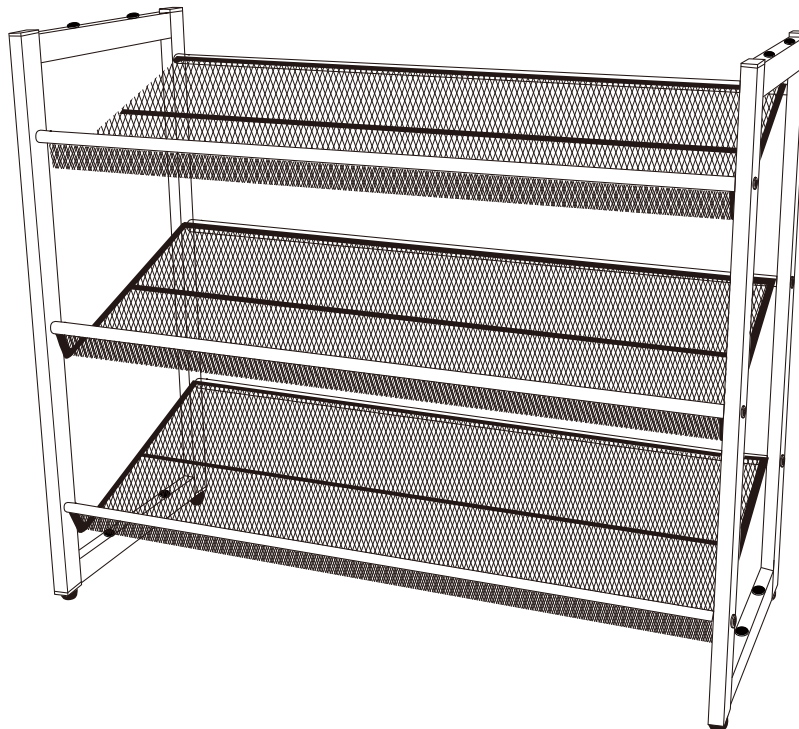

PLEASE NOTE:

We will accept missing parts request with proof of purchase only, within 30 days of purchase.
All return merchandise must be returned directly to the store and not the manufacturer with the proof of purchase.



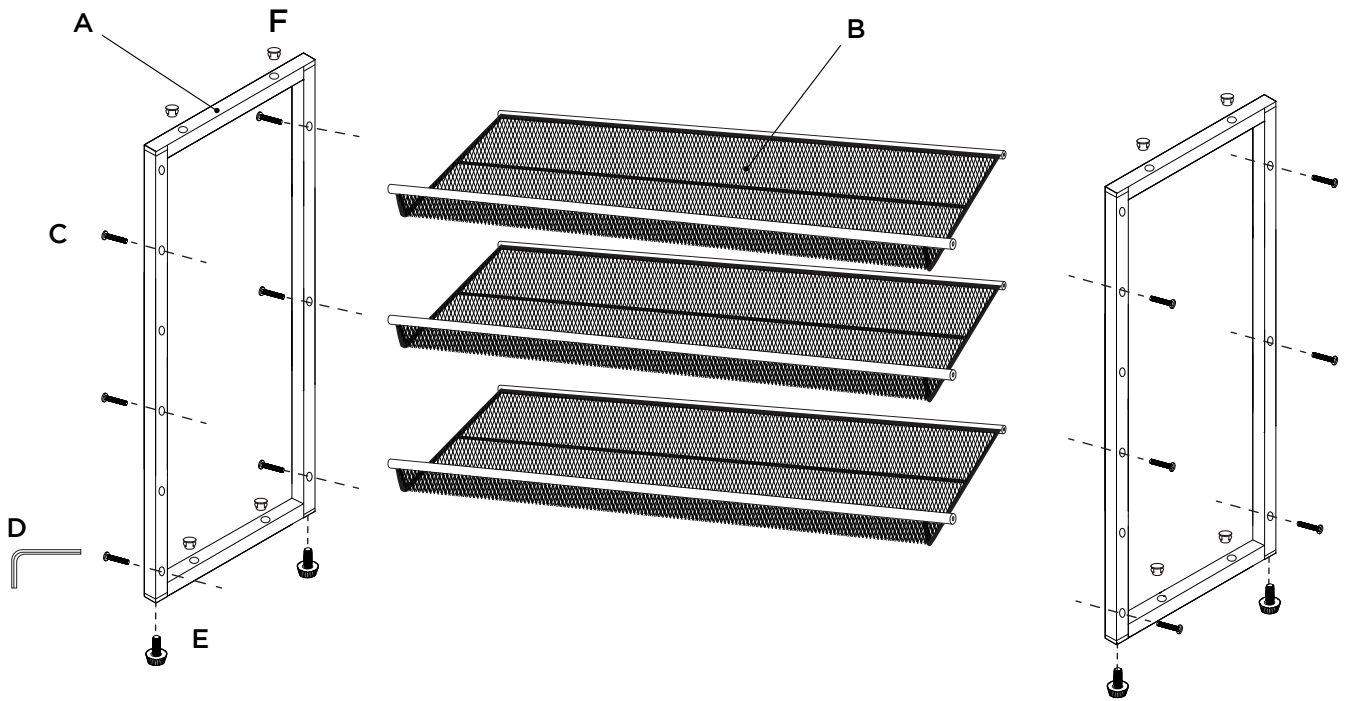

CREATE ANGLE SHELVING

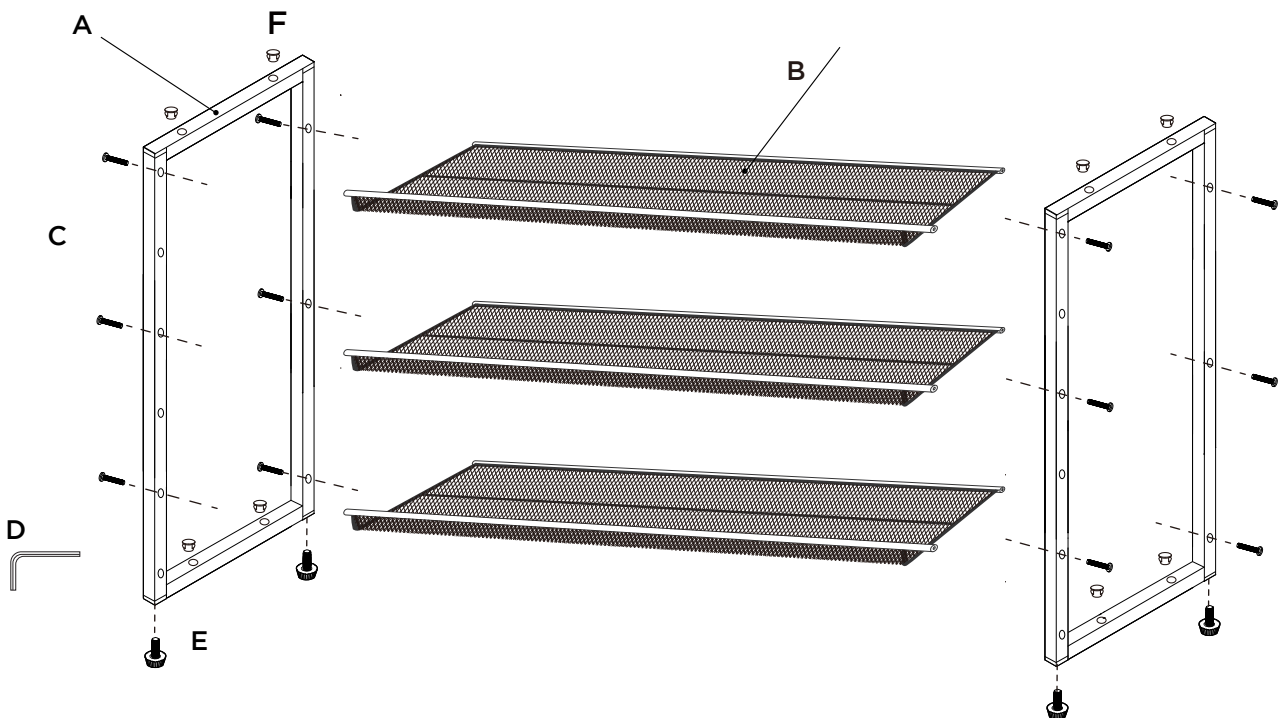

CREATE FLAT SHELVING



WALL MOUNT APPLICATION

#	a	b	c	d
PARTS				
QTY	2	2	2	2

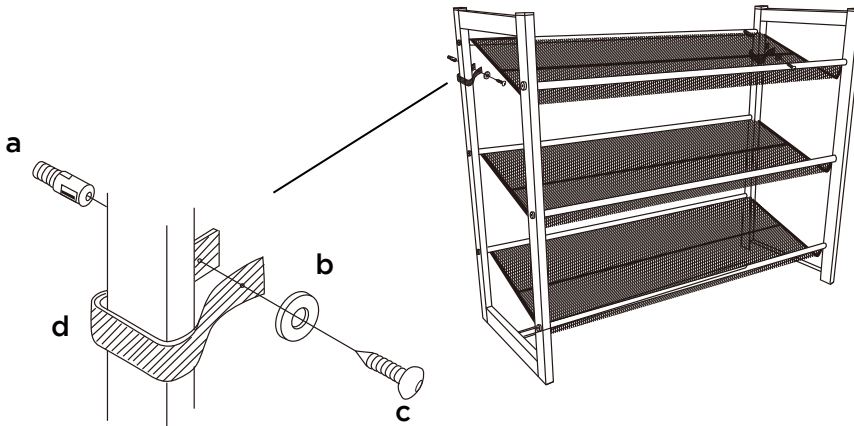

STACKING SHOE RACKS

This step is required only if you are going to purchase two units

